

# Iowa High School Baseball Coaches Association

DECEMBER 1970 NEWSLETTER

Our membership is still growing. We now have 177 members which is 44 more than at this time last year. This is a 28% increase. We should try and sell the organization to the baseball coaches who are new and also to the ones in your league who are not members. Talk to umpires in your area and have them join.

After counting the ballots for the District Baseball Coaches of the Year, I am happy to announce the following men will be honored at the clinic as their District Coach of the Year--Northeast--Dennis Olejniczak, Decorah; Southeast--Bill Lehr, Clinton; Central--Bill Sapp, Boone; Southwest--Tom Vincent--Council Bluffs T. Jefferson; and Northwest--Vic Belger, Fonda OLG. Congratulations are in order to the nominees and the winners.

The Coaches Association will also honor five men who have devoted the majority of their lives to baseball in Iowa and the young men they have coached. They have been selected to enter the Hall of Fame with the previous selections. These men will be informed of this honor in December and it will be announced in March with a news release.

Iowa State University is holding a five-day clinic at Ames December 26 through December 30. The clinic will be open to any youngster who is currently enrolled in junior or senior high school. On the staff will be Cap Timm, ISU Head Coach, Clair Rierson, ISU Asst. Coach, Ron Welsch who pitches for Indianapolis in American Association, Gerry McNertney of the St. Louis Cardinals. We hope you have some young men to send to this fine camp. If you have any questions about it, write or call Clair Rierson in Ames. Congratulations are in order for Cap Timm and Clair Rierson for their promotion of baseball in Iowa.

On the map you will find the results of the election to the Board of Representatives. Their terms will start with the clinic meeting March 12. Congratulations to the winners. They are to represent their district at all Board meetings. If you have anything that is to be brought up or discussed, contact your representative or contact me. The two highest vote winners are the representatives. The third highest vote getter is the alternate who will have a vote if one of his district representatives is absent. All are to attend the clinic meeting.

A big thank you to the past Board Members. I feel a great deal has been accomplished since the beginning of the association.

Now is the time for you to start thinking about your senior ball players and what schools they are planning to attend. A good time to meet the college coaches would be at our clinic March 12 and 13. We will try to get a large turnout of college coaches to attend. This will be an ideal time to get to know our college coaches and talk to them about baseball and your seniors, your program and their program. We had a large number of college coaches the last two years who came to the clinic.

Enclosed you will find a compiled list of coaches and assistant coaches salaries. We hope this will help you improve your salary and have an insight as to what other schools are getting for their coaching. Next month we will have games scheduled and played.--all levels--varsity, junior varsity, sophomores, and junior highs.

Also enclosed you will find a map of memberships. Compare this map with the map in the October 1970 newsletter which showed last year's membership and see the gains and losses. We need to get more assistant coaches involved. Some day they will become head coaches. We are disappointed that more college coaches have not joined. The Coaches Association can be of great help to them. If any of you know an interested umpire, encourage him to join the organization. We need to hit 250! We need your help! Every baseball coach in Iowa should belong to this organization.

We are enclosing some more conference standings. We hope we can get the entire state's conference standings in the future. Also enclosed are some team records who are not in a conference.

We have a weight program for anyone who will attend the clinic. This weight program can be picked up at the clinic. Thanks to Duane Banks, Iowa baseball coach for this program. Mr. Banks also gave us the diagram for the protection screen that you find enclosed. We hope that you can put this information to some use.

A very Merry Christmas and Happy New Year!

CONFERENCE STANDINGS AND INDEPENDENTS RECORDS

Omaha-Council Bluffs Metro Conf.

|                 |      |               |      |
|-----------------|------|---------------|------|
| North           | 12-1 | Rummel        | 7-6  |
| Burke           | 10-3 | West Side     | 6-7  |
| Bishop Ryan     | 10-3 | CB A. Lincoln | 5-8  |
| Creighton Prep  | 8-5  | Central       | 4-8  |
| Benson          | 8-5  | South         | 1-11 |
| CB T. Jefferson | 7-5  | Boys Town     | 0-12 |
| Bellevue        | 7-6  | Tech          |      |

Little 8

|                   |      |
|-------------------|------|
| Stuart            | 12-2 |
| Adair-Casey       | 12-2 |
| Earlham           | 11-3 |
| C-M (Cumberland)  | 8-6  |
| B-F (Fontantelle) | 5-9  |
| O-M (Orient)      | 4-10 |
| Menlo             | 3-11 |
| Anita             | 1-13 |

Siouxland

|                     |      |
|---------------------|------|
| Boyden-Hull         | 12-2 |
| George              | 9-5  |
| Rock Valley         | 9-5  |
| West Lyon           | 8-6  |
| Sioux Center        | 6-8  |
| Central Lyon        | 6-8  |
| Akron               | 3-11 |
| Maurice-Orange City | 3-11 |

Southeast Iowa Conf.

|                    |     |
|--------------------|-----|
| Mediapolis         | 7-2 |
| Wapello            | 7-2 |
| Winfield-Mt. Union | 6-3 |
| Highland           | 6-3 |
| Columbus Comm.     | 5-4 |
| New London         | 5-4 |
| Danville           | 4-5 |
| Lone Tree          | 4-5 |
| Louisa Muscatine   | 1-8 |
| Morning Sun        | 0-9 |

Corner Conference

|               |     |
|---------------|-----|
| Essex         | 7-1 |
| Nishna Valley | 7-1 |
| Fremont Mills | 7-1 |

Big Marsh Conference

|                 |      |
|-----------------|------|
| Allison-Bristow | 11-1 |
| Aplington       | 9-3  |
| Plainfield      | 9-3  |
| Dumont          | 6-6  |
| New Hartford    | 4-8  |
| Parkersburg     | 3-9  |
| Clarksville     | 1-11 |

North Iowa Cedar League

|               |     |
|---------------|-----|
| LaPorte City  | 9-1 |
| Grundy Center | 6-4 |
| Eldora        | 5-5 |
| Orange        | 5-5 |
| Ackley-Geneva | 2-7 |
| N. U. H. S.   | 1-8 |

INDEPENDENTS RECORDS

|                                 |       |                                |       |
|---------------------------------|-------|--------------------------------|-------|
| West Bend                       | 12-13 | Garrigan (                     | 17-5  |
| Lewis Central (Hawkeye 7)       | 11-3  | LDF LeGrand (TA-MA-JA Conf)    | 13-9  |
| West Wood (Tri-County)          | 13-4  | Colfax (Des Moines River)      | 4-9   |
| Northwood Kensett (N. Ia Chmps) | 9-3   | Winterset (South Cent. Conf)   | 6-11  |
| Central City                    | 9-5   | Reinbeck (Mid-Iowa)            | 5-9   |
| Corning                         | 5-5   | Chariton (South Cent.)         | 14-7  |
| St. Dodge St. Edmond            | 7-14  | Woden Crystal Lake (St. Line)  | 3-7   |
| Sioux City Heelan               | 23-7  | Remsen St. Mary's (Quad Conf)  | 5-3   |
| Twin Rivers (Twin Lakes)        | 9-5   | St. Johns Bancroft (F, SP SUM) | 48-10 |
| Amana (Benton)                  | 12-10 | Preston                        | 5-13  |
| Fairfield                       | 22-12 | Essex                          | 7-1   |
| Burlington                      | 32-15 | Jefferson (Midwest Sum Lg)     | 7-11  |
| Pekin                           | 4-10  | Storm Lake St. Marys)          | 6-3   |
| Northeast Comm                  | 8-12  | Floyd Valley                   | 18-4  |

SALARY SURVEY On 1970 SEASON

| School               | Head Coach Spr.-Summ. | Asst Coach Spr.-Summ. | # of Asst | School           | Head Coach Spr.-Summ. | Asst Coach Spr.-Summ. | # of Asst |
|----------------------|-----------------------|-----------------------|-----------|------------------|-----------------------|-----------------------|-----------|
| Ames                 | 880                   | 440                   | 1         | Allison Bristow  | 500                   |                       |           |
| Calamus              | 4 1/2% Base<br>900    |                       |           | Dysart-Geneseo   | 450                   | 400                   |           |
| Lewis Central        | 900                   | 550                   | 1         | Des Moines Sch   | 1000                  | 600                   | 1         |
| West Bend            | 615                   |                       |           | Harpton          | 600                   |                       |           |
| Monticello           | 685                   |                       |           | NESCO            | 400                   |                       |           |
| Osage                | 550                   |                       |           | Ft. Dodge        | 900                   | 550                   | 1         |
| Westwood             | 600                   | 400                   | 1         | Perry            | 828                   | 552                   | 1         |
| Northwood Kensett    | 612                   |                       |           | Beaman-Conrad    | 1000                  |                       |           |
| Mid Prairie          | 515                   |                       |           | CR Prairie       | 1020                  | 850                   | 2         |
| Central City         | 425                   |                       |           | Mason City       | 750                   | 375                   | 1         |
| Moline, Ill          | 1240                  | 860                   | 2         | Twin Rivers      | 475                   | 375                   | 1         |
| Storm Lake-St Marys  | 700                   |                       |           | Linn Mar         | 885                   | 675                   | 1         |
| Corning              | 700                   | 400                   | 1         | Norway           | 300                   | 300                   | 1         |
| Reinbeck             | 544                   |                       |           | Clinton          | 750                   | 500                   | 1         |
| Anamosa              | 845                   |                       |           | Pekin            | 668                   |                       |           |
| Fonda OLG            | 275                   |                       |           | Burlington       | 800                   | 550                   | 1         |
| Ft. Dodge St. Edmond | 25                    |                       |           | Fairfield        | 750                   | 200                   | 1         |
| Sioux City Heelan    | 1000                  |                       |           | Amana            | 300                   |                       |           |
| Colfax               | 330                   |                       |           | Northeast Comm   | 700                   |                       |           |
| Lost Nation          | 350                   |                       |           | Indianola        | 914                   |                       |           |
| Lisbon               | 345                   |                       |           | Council Bluffs   | 1000                  | 500                   | 1         |
| Keokuk               | 600                   |                       |           | Davenport Sch.   | 850                   | 650                   | 2         |
| Urbandale            | 700                   | 350                   | 1         | Cedar Rapids Sch | 615                   | 600                   | 2         |
| Guttenberg           | 612                   |                       |           | Iowa City Sch.   | 893                   | 550                   | 1         |
| Eldora               | 425                   |                       |           | Cedar Rapids JH  | 570                   | 400                   | 1         |
| LDF LeGrand          | 600+10% raise         |                       |           |                  | 720                   |                       |           |
| Garrigan             | 700                   |                       |           |                  |                       |                       |           |
| Alden Comm.          | 750                   |                       |           |                  |                       |                       |           |
| North Tama           | 450                   |                       |           |                  |                       |                       |           |

1971 BOARD OF REPRESENTATIVES AND OFFICERS

# Iowa High School Baseball Coaches Association

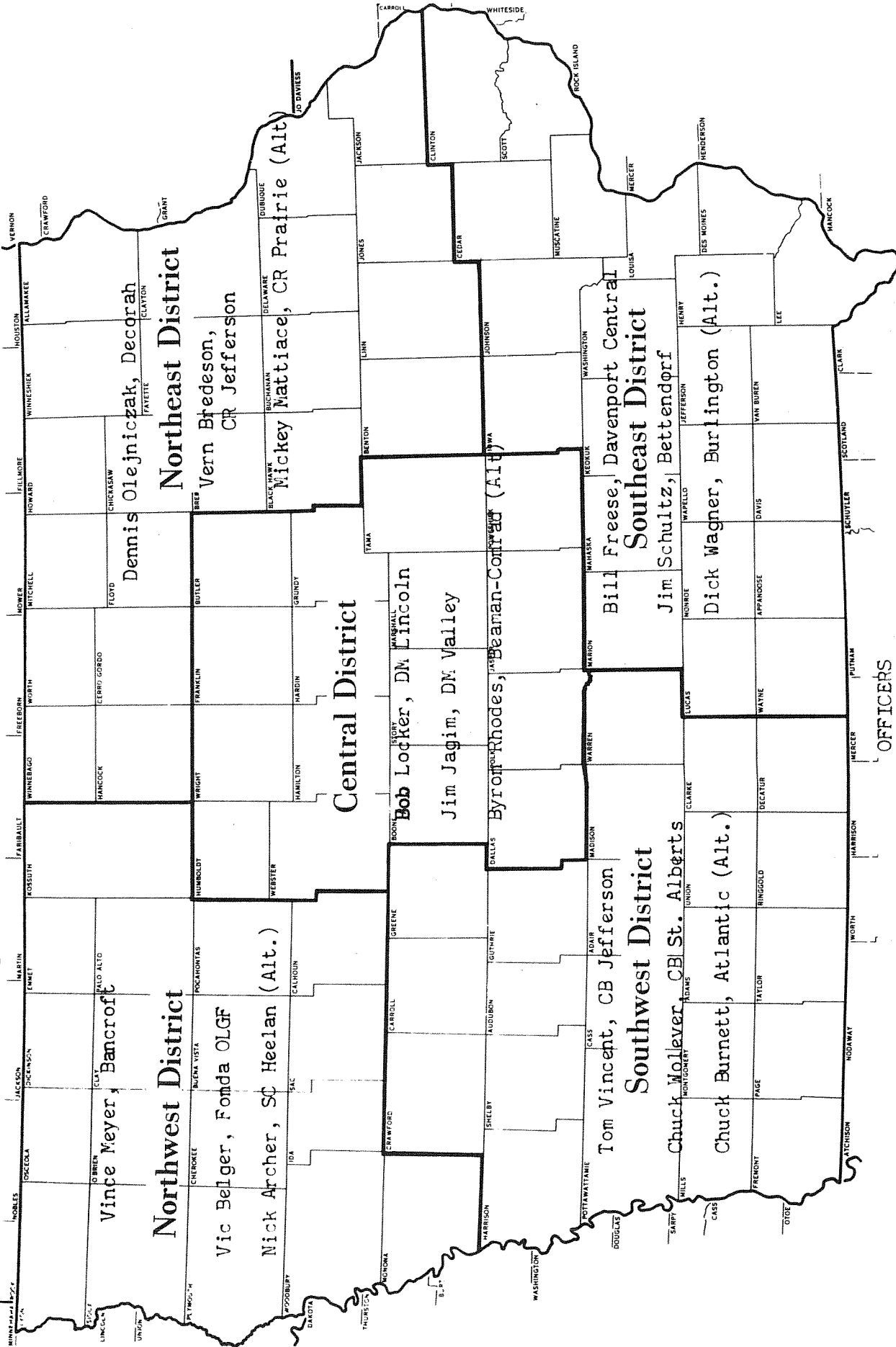

President--Harold Primrose, CR Washington  
 Secretary--Dave Hoyt, CR Washington

Vice-President--Elmer Starr, Mason City  
 Treasurer--Bernie Hutchison, Norway

OFFICERS

# Iowa High School Baseball Coaches Association

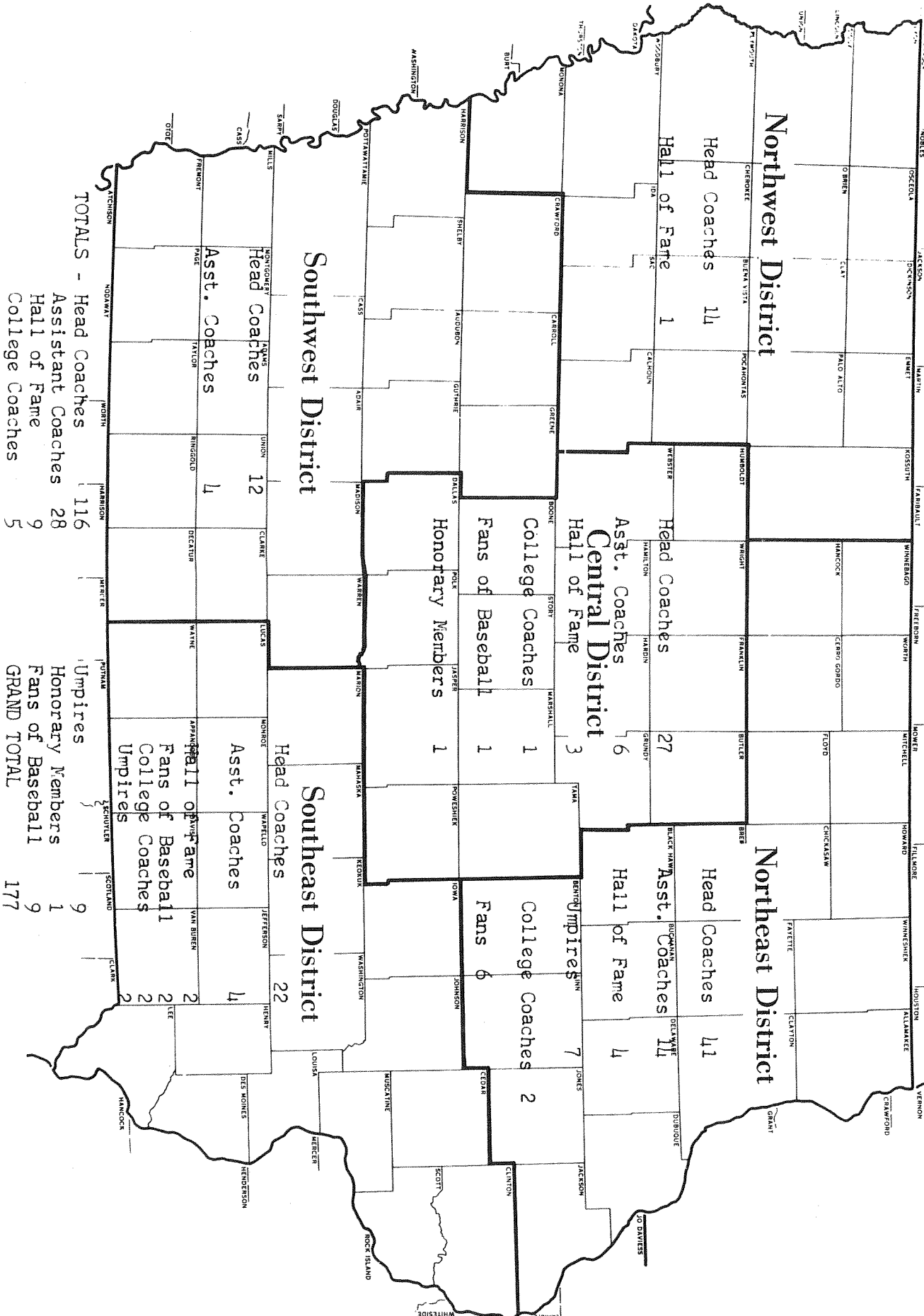

TOTALS - Head Coaches 116  
 Assistant Coaches 28  
 Hall of Fame 9  
 College Coaches 5

Umpires 9  
 Honorary Members 1  
 Fans of Baseball 9  
 GRAND TOTAL 177

STRING PITCHING TARGET

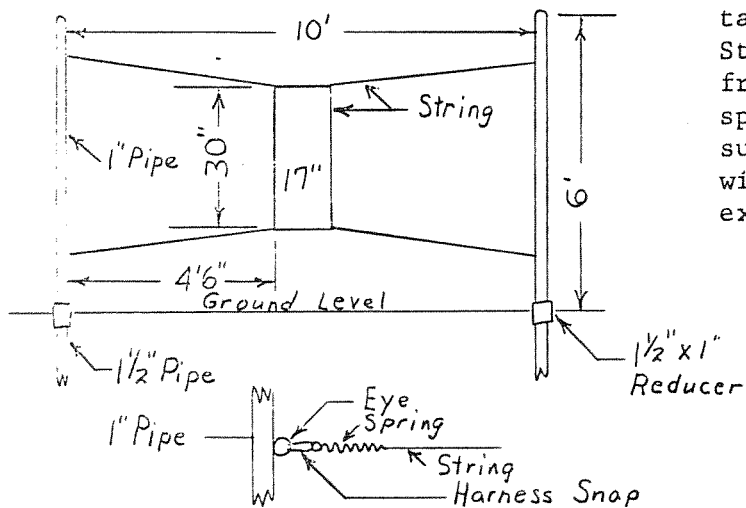

This is of great assistance in developing control for pitchers. The string is heavy cord. Corners can be taped lightly to eliminate sliding. String should be placed above the front edge of a home plate. The spring attachment on the pipes insures longer wear on the string and with a small harness snap attachment expedites removal.

Attachment of string to pipe

FIRST BASE PROTECTOR

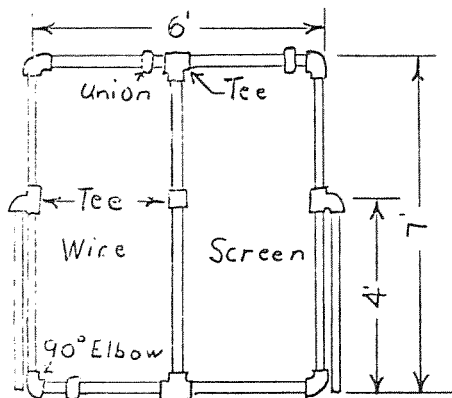

Front View

Frame of 1" Pipe

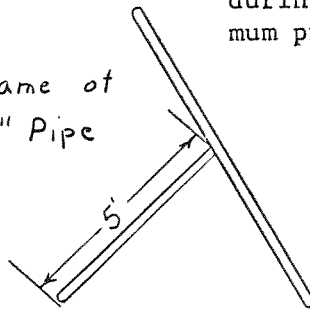

Side View

Place 15-20 feet down 1B-Home base line. Enables first basemen to take throws from infielders during batting drills with maximum protection.

PITCHER PROTECTOR

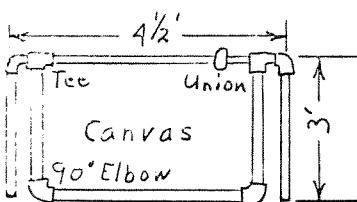

Front View

Frame of 1" Pipe

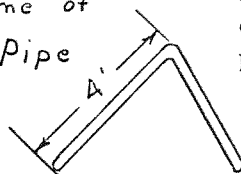

Side View

Protects pitchers from hard-hit liners and grounders during batting drills. Grommets in dark canvas permit lacing on frame of protector.

